



For Planners, Architects and Operators  
CKL evo compact ventilation unit



# CKL evo compact ventilation unit

Fast and perfect, from planning to site

# The standard for compact units – new and improved



• Top-class  
plug & play

• Highest quality and hy-  
giene standards

• Additional  
control functions

• Extensive  
accessories available

• Short delivery  
times



D1





TB2



**Standard  
powder-coated  
casing in white (RAL 9016)**

Improved casing properties (best casing values as per DIN EN 1886):

- T2 Thermal insulation
- TB2 Thermal bridge factor
- D1 Mechanical stability
- L1 Housing leakage

L1



# WOLF CKL evo

The standard for compact units – new and improved

## The possibilities just keep growing

The highest quality and hygiene standards, unparalleled compactness combined with intelligent ease of installation – properties that already make the CKL compact device series a success. And the EVolution begins: With practical, state-of-the-art new features and increased performance values, WOLF has completely revised the product series.

Thanks to the outstanding achievements of our development engineers: Higher air handling rates at the same or smaller appliance dimensions compared with the previous product line.

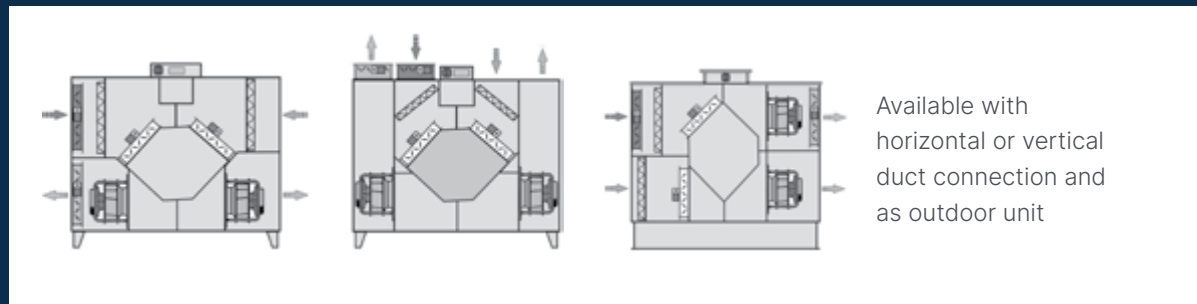
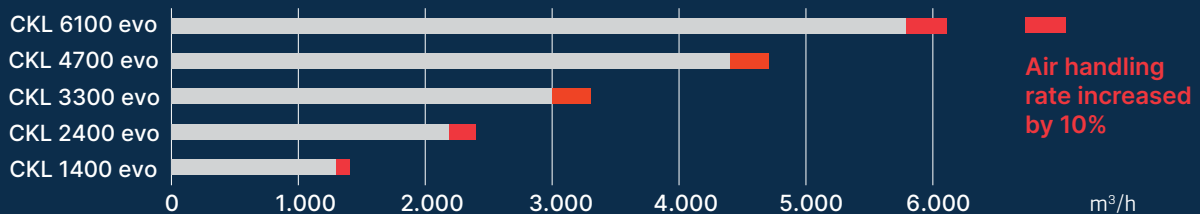

## Numerous extension options:

- Expanded integrated control
- Even more accessories
- Increased heating output
- Equipped to satisfy all standards:
  - Double filter and pocket filter module
- Monitoring of the system with simple Smartset access via app and PC

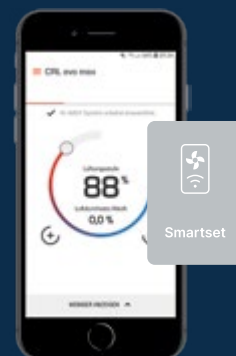

# Developed for hygienic, efficient operation and simple maintenance.

## Hygienic & orderly

Unique: Cable harness in the back wall for smooth surfaces in the appliance.

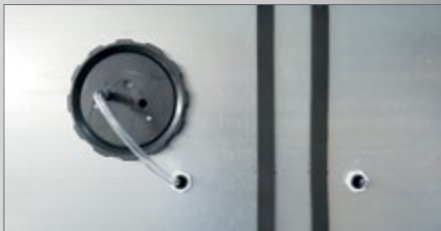

Manometer tubing within the door



Double filter stage for maximum hygiene.



Eurovent and RLT certified as standard, VDI 6022 compliant



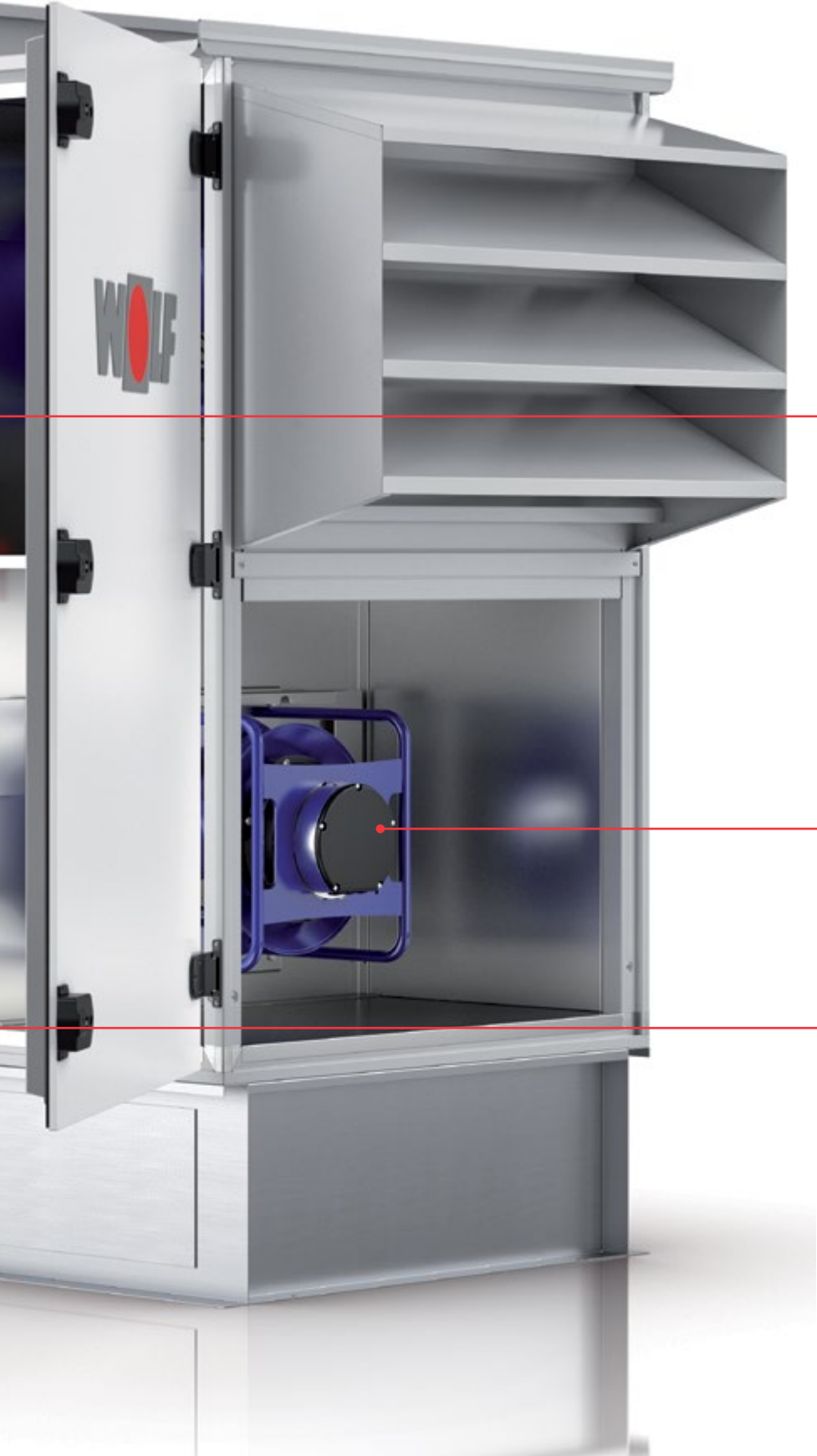

### Simple operation

New touch programming unit for operating the entirely integrated control.

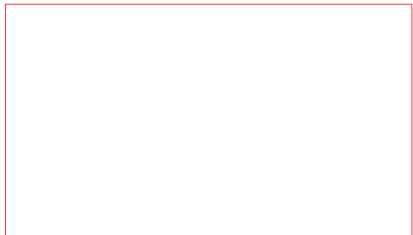

### Ice Protect

Maximum efficiency in bypass mode thanks to Ice Protect technology



### Maximum efficiency

Fans of the newest generation.

### Boost damper

Unique operating modes for the very highest efficiency through clever use of circulating air with the boost damper.

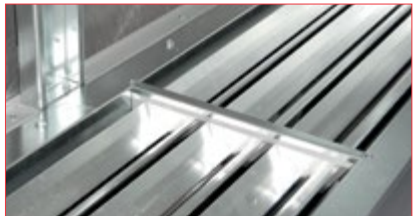

# By perfectionists for experts

The most installation-friendly appliance on the market.



Extremely compact dimensions



Unique lengthwise separation for easy positioning of the larger CKL 4700 evo and CKL 6100 evo indoor units



Easy lifting makes handling at the construction site child's play



No need to drill holes in outdoor units for running supply lines



**Heating, cooling, ventilation – all in a single package.**

The Clima Split system is easy to expand and can be installed in just a few steps.



Easy  
Lifting  
Lugs



Made in  
Germany  
by WOLF

## Indoor installation model

		CKL-iH/-iV-1400 evo	CKL-iH/-iV-2400 evo	CKL-iH/-iV-3300 evo	CKL-iH/iV-4700 evo	CKL-iH/iV-6100 evo
Nominal flow rate	m <sup>3</sup> /h	1400	2400	3300	4700	6100
Length (with/without boost damper)	mm	1525	2033	2033	2237	2237
Depth	mm	750	750	950	1360	1665
Total height	mm	1309 / 1315	1716 / 1720	1716 / 1720	1716 / 1424	1716 / 1424
Duct connection dimensions, horizontal air routing	mm	Left 612×409 / 596×206	Left 612×612 / 596×307	Left 815×612 / 799×307	Li 1222×612 / 1222×356	Li 1527×612 / 1527×356
Weight of basic unit	kg	250	360	450	645	725

iH: Indoor installation with horizontal duct connections

iV: Indoor installation with vertical duct connections

## Outdoor installation model

		CKL-A-1400 evo	CKL-A-2400 evo	CKL-A-3300 evo	CKL-A-4700 evo	CKL-A-6100 evo
Nominal flow rate	m <sup>3</sup> /h	1400	2400	3300	4700	6100
Length (with/without boost damper, without hood)	mm	1525	2033	2033	2237	2237
Depth (incl. roof)	mm	815	815	1017	1425	1730
Total height	mm	1455	1860	1860	1860	1860
Duct connection dimensions, horizontal air routing	mm	Left 612×409	Left 612×612	Left 815×612	Left 1222 × 612	Left 1527 × 612
Weight	kg	315	460	555	715	800

If you have any questions about this brochure,  
please contact us at [feedback@wolf.eu](mailto:feedback@wolf.eu)

You can find a local contact on our website:  
[www.wolf.eu/wolf-worldwide](http://www.wolf.eu/wolf-worldwide)



We look forward to  
hearing from you.

Subject to technical modifications. Please note that only the WOLF product is shown in the images of the product. You will usually need incoming and outgoing lines which are connected to the WOLF product from the outside. The WOLF Group makes no guarantees or warranties regarding the accuracy of this brochure. Some images show special accessories.

WOLF GmbH  
Postfach 13 80  
D-84048 Mainburg  
Tel. +49 (0)8751 74-0  
Email [info@wolf.eu](mailto:info@wolf.eu)  
[www.wolf.eu](http://www.wolf.eu)



Perfectly in tune with you.

EN/02.25 part. no. 4801838